

This drawing is the property of HDIBT Corp. and should not be disclosed to any third party without prior permission of HDIBT Corp..

REV. NO		REV. HISTORY	LTR	ECO NO	DATE	APPR'L
DWG	PART					
00	00	INITIAL RELEASE	-	-	-	-

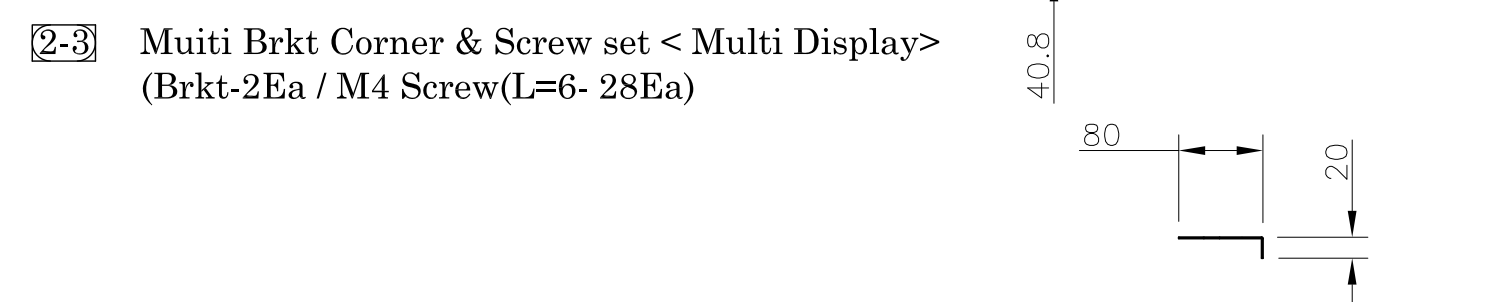
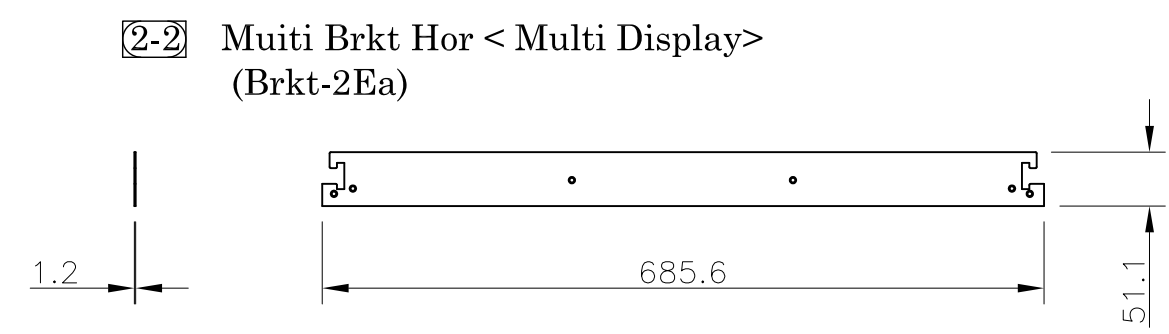
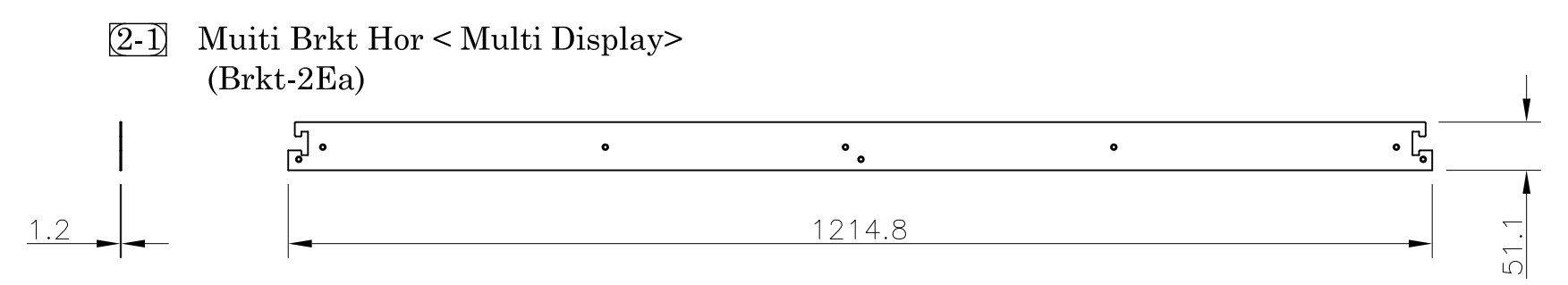
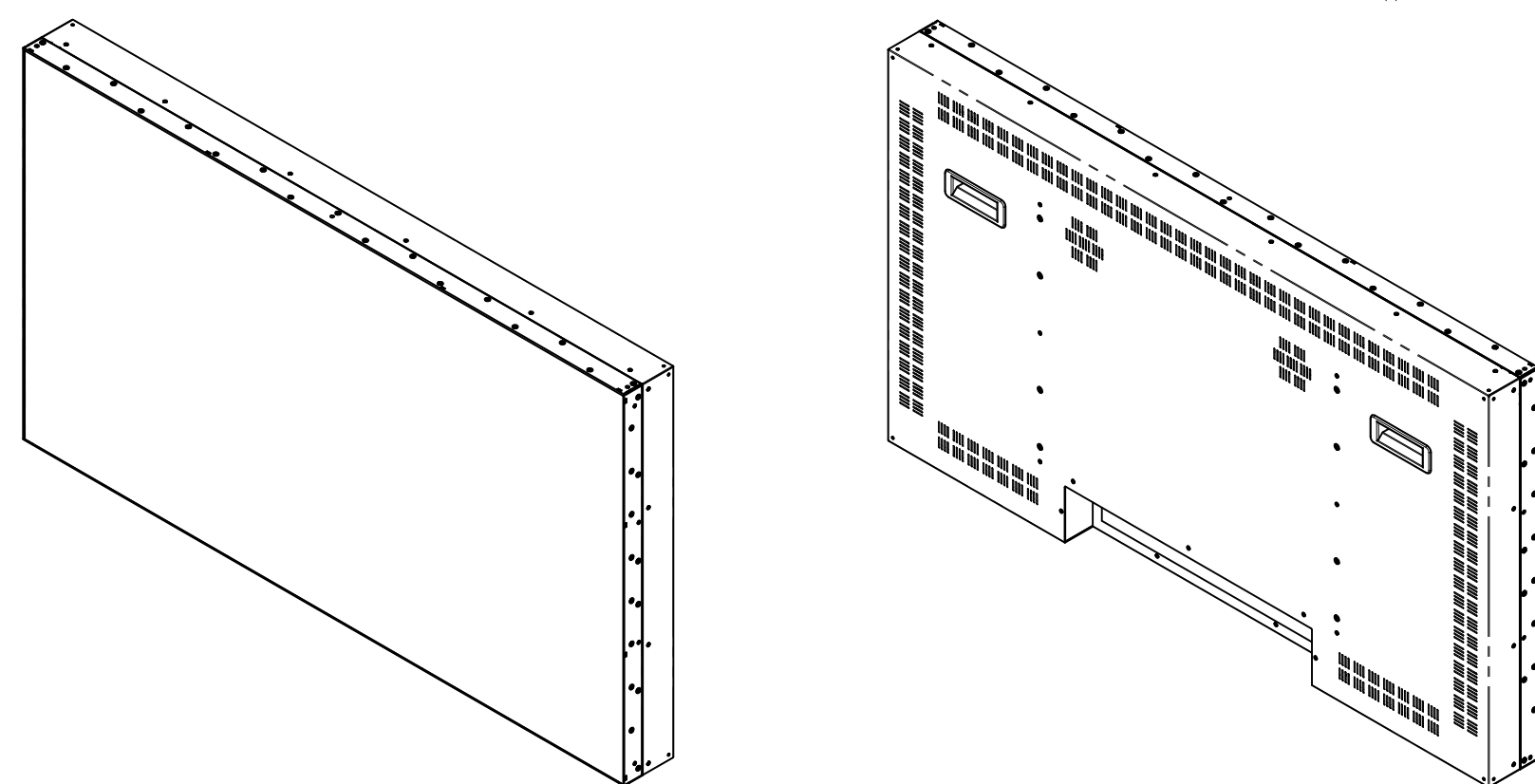
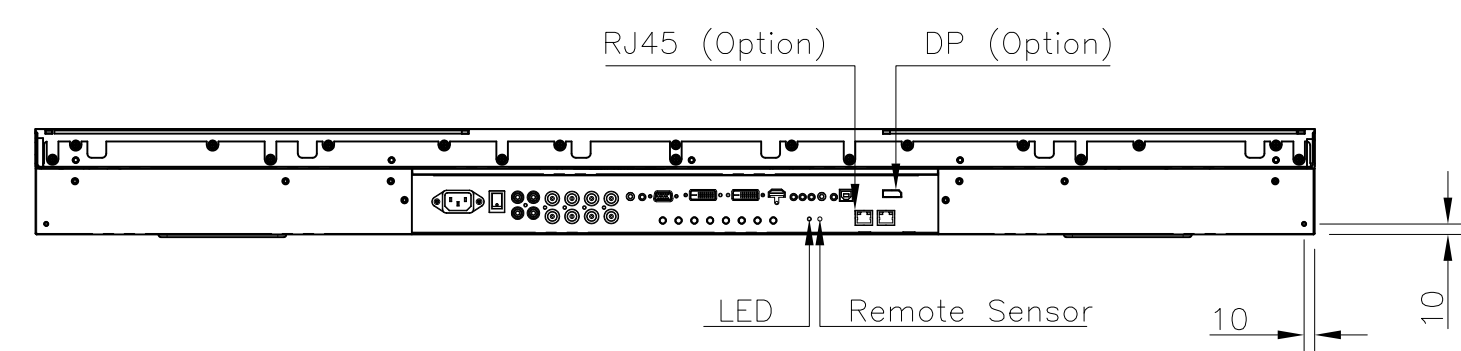
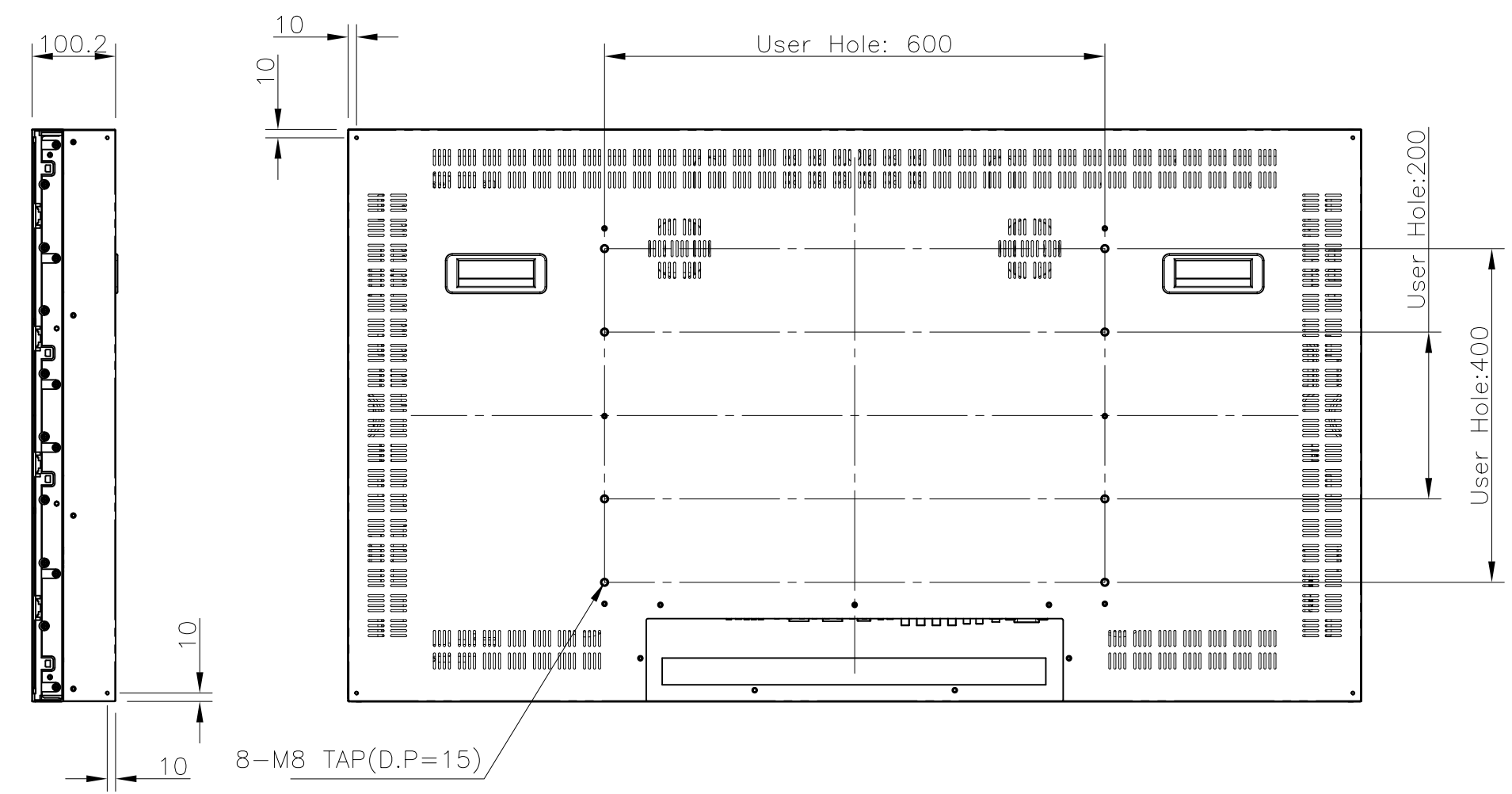
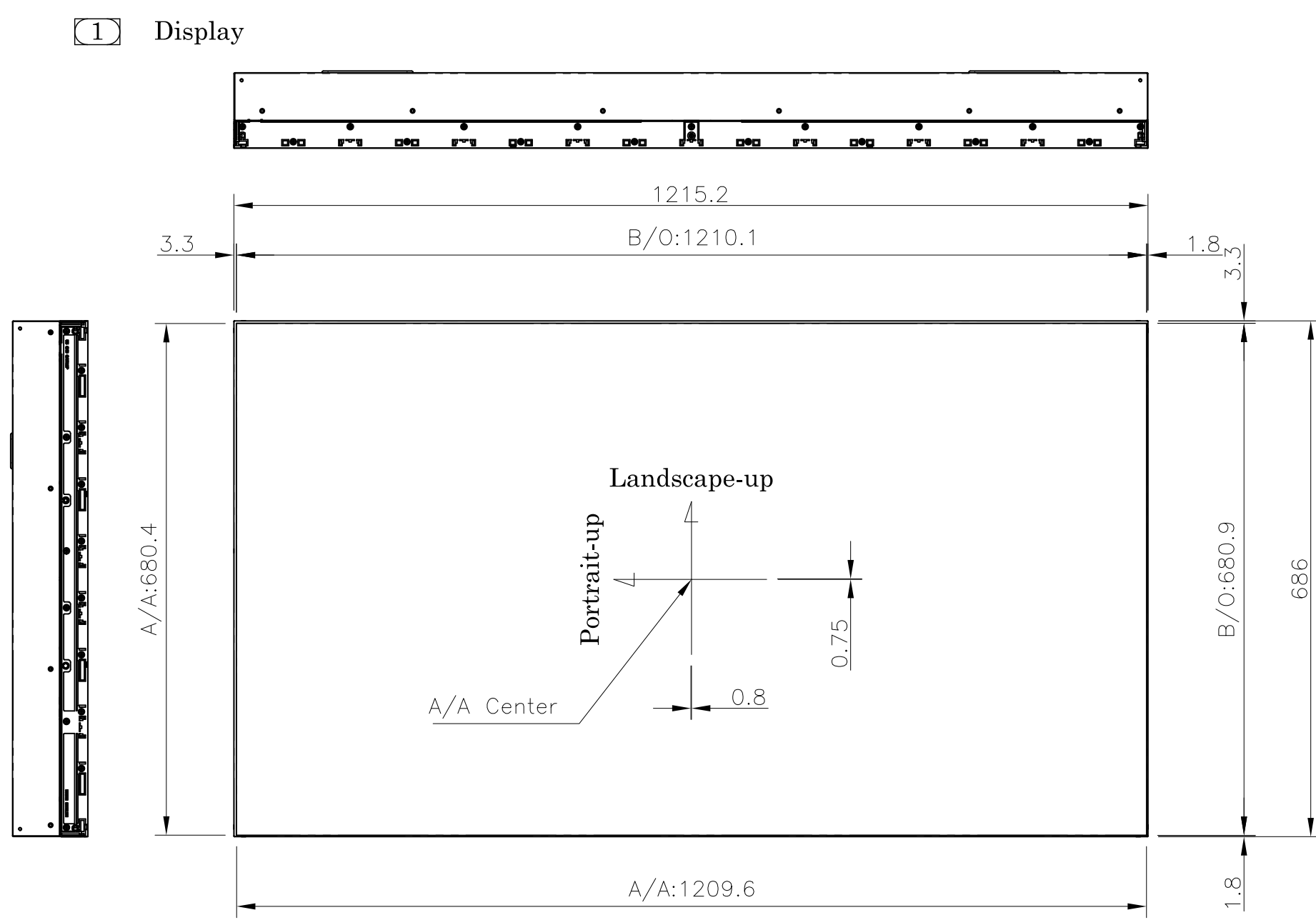

- NOTES,**
- LCD Panel : 55" SNB
 - Material : E.G.I
 - Color : Black
 - Net Weight : 33Kg

DRAWN	PLANNED	CHECKED	APPROVED	UNLESS OTHERWISE SPECIFIED ALL DIMENSION ARE IN MILLIMETERS	ANGLE 3rd.	TITLE : D558FB/D552FB EXTERIOR VIEW	UNIT : mm
S.H.JANG	S.H.JANG	-	Y.T.KIM	TOLERANCES ARE : LINEAR : X ± 0.2 .X ± 0.1 .XX ± 0.01 ANGLES : ± 0.1° RADII UNLESS NOTED : R 0.3	SCALE : 1/10		TYPE : ASSY
'14.10.27	'14.10.27	-	'14.10.27	MODEL NAME (CODE): D558FB/D552FB	CUSTOMER. HDIT	DWG REV : 00	SIZE : A3
				FILE NAME : LAYOUT_D558FA_D558FB_LGD_141027_APPV.DWG		DWG(PART) NO. D558FB_001	